

EXHIBIT 1 TO COMPLAINT

Certificate of Registration



This Certificate issued under the seal of the Copyright Office in accordance with title 17, *United States Code*, attests that registration has been made for the work identified below. The information on this certificate has been made a part of the Copyright Office records.

Shirley P. Weinstock

United States Register of Copyrights and Director

Registration Number

PAu 4-160-494

Effective Date of Registration:

November 11, 2022

Registration Decision Date:

December 21, 2022

Title

Title of Work: TTR-Video-3

Completion/Publication

Year of Completion: 2013

Author

- Author:** TR Tools, LLC
- Author Created:** entire motion picture
- Work made for hire:** Yes
- Citizen of:** United States

Copyright Claimant

Copyright Claimant: TR Tools, LLC
608 15th Street SE, Orange City, IA, 51041, United States

Limitation of copyright claim

Material excluded from this claim: preexisting music

New material included in claim: all other cinematographic material

Rights and Permissions

Organization Name: TR Tools, LLC
Address: 608 15th Street SE
Orange City, IA 51041 United States

Certification

Name: Jessica Delos Santos

Certificate of Registration



This Certificate issued under the seal of the Copyright Office in accordance with title 17, *United States Code*, attests that registration has been made for the work identified below. The information on this certificate has been made a part of the Copyright Office records.

Shirley Perlmutter
United States Register of Copyrights and Director

Registration Number

VA 2-327-778

Effective Date of Registration:

November 11, 2022

Registration Decision Date:

November 16, 2022

Title

Title of Work: TTR-033

Completion/Publication

Year of Completion: 2017
Date of 1st Publication: May 30, 2017
Nation of 1st Publication: United States

Author

• Author: TR Tools, LLC
Author Created: photograph
Work made for hire: Yes
Citizen of: United States

Copyright Claimant

Copyright Claimant: TR Tools, LLC
608 15th Street SE, Orange City, IA, 51041, United States

Rights and Permissions

Organization Name: TR Tools, LLC
Address: 608 15th Street SE
Orange City, IA 51041 United States

Certification

Name: Jessica Delos Santos
Date: November 11, 2022

Copyright Office notes: Regarding basis for registration: Registration does not extend to any useful article depicted. Registration extends to deposited photograph only. 17 USC 101, 102(a), and 113.

Certificate of Registration



This Certificate issued under the seal of the Copyright Office in accordance with title 17, *United States Code*, attests that registration has been made for the work identified below. The information on this certificate has been made a part of the Copyright Office records.

Shirley R. Primm

United States Register of Copyrights and Director

Registration Number

VA 2-328-515

Effective Date of Registration:

November 11, 2022

Registration Decision Date:

November 22, 2022



Copyright Registration for a Group of Published Photographs

Registration issued pursuant to 37 C.F.R. § 202.4(i)

For Photographs Published: February 14, 2019 to February 26, 2019

Title

Title of Group: Tite Reach Product Pictures 2019
Number of Photographs in Group: 24

- **Individual Photographs:** TTR-01,
TTR-02,
TTR-03,
TTR-04,
TTR-05,
TTR-06,
TTR-07,
TTR-08,
TTR-09,
TTR-010,
TTR-011,
TTR-012,
TTR-013,
TTR-014,
TTR-015,
TTR-016,
TTR-017,
TTR-018,
TTR-019,
TTR-020,
TTR-021,
TTR-022,
TTR-023,
TTR-024

Published: February 2019

Completion/Publication

Year of Completion: 2019
Earliest Publication Date in Group: February 14, 2019
Latest Publication Date in Group: February 26, 2019
Nation of First Publication: United States

Author

- **Author:** TR Tools, LLC
Author Created: photographs
Work made for hire: Yes
Citizen of: United States

Copyright Claimant

Copyright Claimant: TR Tools, LLC
608 15th Street SE, Orange City, IA, 51041, United States

Rights and Permissions

Organization Name: TR Tools, LLC
Address: 608 15th Street SE
Orange City, IA 51041 United States

Certification

Name: Jessica Delos Santos
Date: November 11, 2022

Copyright Office notes: Regarding title information: Deposit contains complete list of titles that correspond to the individual photographs included in this group.

Regarding group registration: A group of published photographs may be registered on one application with one filing fee only under limited circumstances. ALL of the following are required: 1. All photographs (a) were created by the same author AND (b) are owned by the same copyright claimant AND (c) were published in the same calendar year AND 2. The group contains 750 photographs or less AND 3. A sequentially numbered list of photographs containing the title, file name and month of publication for each photograph included in the group must be uploaded along with other required application materials. The list must be submitted in an approved document format such as .XLS or .PDF. The file name for the numbered list must contain the title of the group and the Case Number assigned to the application.

Certificate of Registration



This Certificate issued under the seal of the Copyright Office in accordance with title 17, *United States Code*, attests that registration has been made for the work identified below. The information on this certificate has been made a part of the Copyright Office records.



Shirya Perlmutter

United States Register of Copyrights and Director

Registration Number

VA 2-329-848

Effective Date of Registration:

November 17, 2022

Registration Decision Date:

December 05, 2022

Title

Title of Work: TTR-028

Completion/Publication

Year of Completion: 2019
Date of 1st Publication: February 22, 2019
Nation of 1st Publication: United States

Author

Author: TR Tools, LLC
Author Created: technical drawing
Work made for hire: Yes
Citizen of: United States

Copyright Claimant

Copyright Claimant: TR Tools, LLC
608 15th Street SE, Orange City, IA, 51041, United States

Rights and Permissions

Organization Name: TR Tools, LLC
Address: 608 15th Street SE
Orange City, IA 51041 United States

Certification

Name: Jessica Delos Santos
Date: November 17, 2022

Tite-Reach Copyright Summary

Video	Filename	Registration #
	<p>TTR-Video-3</p> <p>3/8" DIY Tite-Reach</p>	<p>PAu 4-160-494</p> <p>Reg. Date 11/11/2022</p>

Image	Filename	Registration #
	<p>TTR-01</p>	<p>VA 2-328-515</p> <p>Reg. Date 11/11/2022</p>
	<p>TTR0-2</p>	<p>VA 2-328-515</p> <p>Reg. Date 11/11/2022</p>
	<p>TTR-03</p>	<p>VA 2-328-515</p> <p>Reg. Date 11/11/2022</p>
	<p>TTR-04</p>	<p>VA 2-328-515</p> <p>Reg. Date 11/11/2022</p>

	<p>TTR-05</p>	<p>VA 2-328-515</p> <p>Reg. Date 11/11/2022</p>
	<p>TTR-06</p>	<p>VA 2-328-515</p> <p>Reg. Date 11/11/2022</p>
	<p>TTR-07</p>	<p>VA 2-328-515</p> <p>Reg. Date 11/11/2022</p>
	<p>TTR-08</p>	<p>VA 2-328-515</p> <p>Reg. Date 11/11/2022</p>
	<p>TTR-09</p>	<p>VA 2-328-515</p> <p>Reg. Date 11/11/2022</p>
	<p>TTR-010</p>	<p>VA 2-328-515</p> <p>Reg. Date 11/11/2022</p>



TTR-011

VA 2-328-515

Reg. Date
11/11/2022



TTR-012

VA 2-328-515

Reg. Date
11/11/2022



TTR-013

VA 2-328-515

Reg. Date
11/11/2022



TTR-014

VA 2-328-515



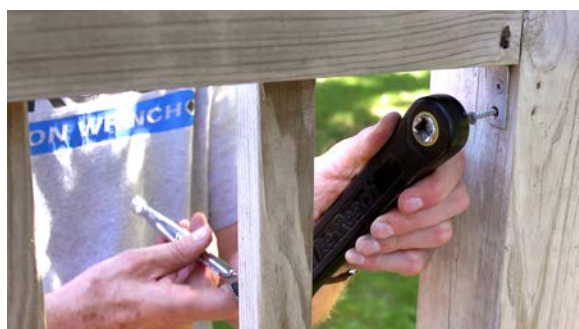

Reg. Date
11/11/2022





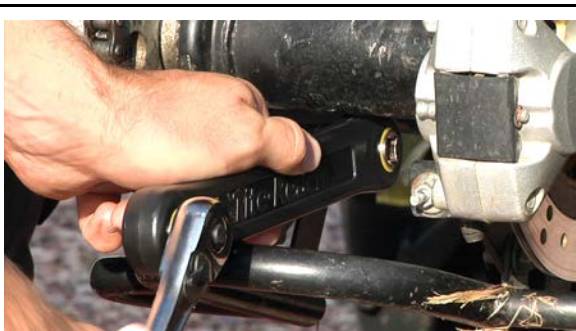

TTR-015

VA 2-328-515

Reg. Date
11/11/2022

	<p>TTR-016</p>	<p>VA 2-328-515</p> <p>Reg. Date 11/11/2022</p>
	<p>TTR-017</p>	<p>VA 2-328-515</p> <p>Reg. Date 11/11/2022</p>
	<p>TTR-018</p>	<p>VA 2-328-515</p> <p>Reg. Date 11/11/2022</p>
	<p>TTR-019</p>	<p>VA 2-328-515</p> <p>Reg. Date 11/11/2022</p>
	<p>TTR-020</p>	<p>VA 2-328-515</p> <p>Reg. Date 11/11/2022</p>

	<p>TTR-021</p>	<p>VA 2-328-515</p> <p>Reg. Date 11/11/2022</p>
	<p>TTR-022</p>	<p>VA 2-328-515</p> <p>Reg. Date 11/11/2022</p>
	<p>TTR-023</p>	<p>VA 2-328-515</p> <p>Reg. Date 11/11/2022</p>
	<p>TTR-024</p>	<p>VA 2-328-515</p> <p>Reg. Date 11/11/2022</p>



TTR-025

VA 2-328-515

Reg. Date
11/11/2022

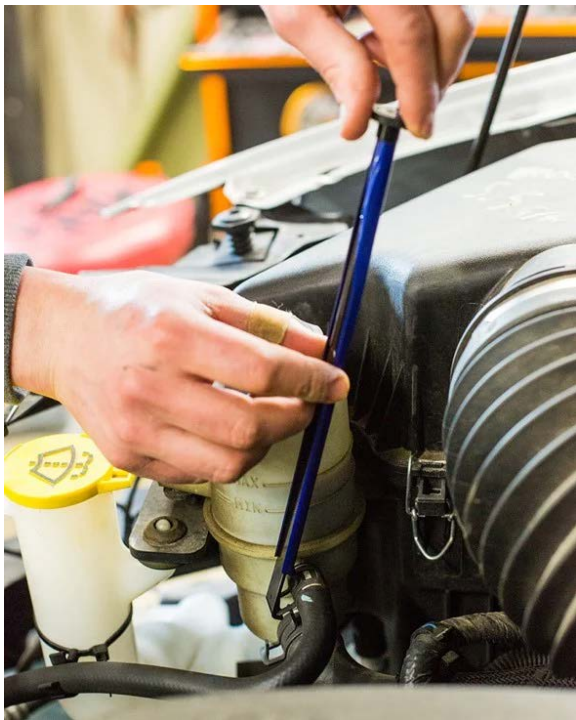

TTR-026

VA 2-328-515

Reg. Date
11/11/2022

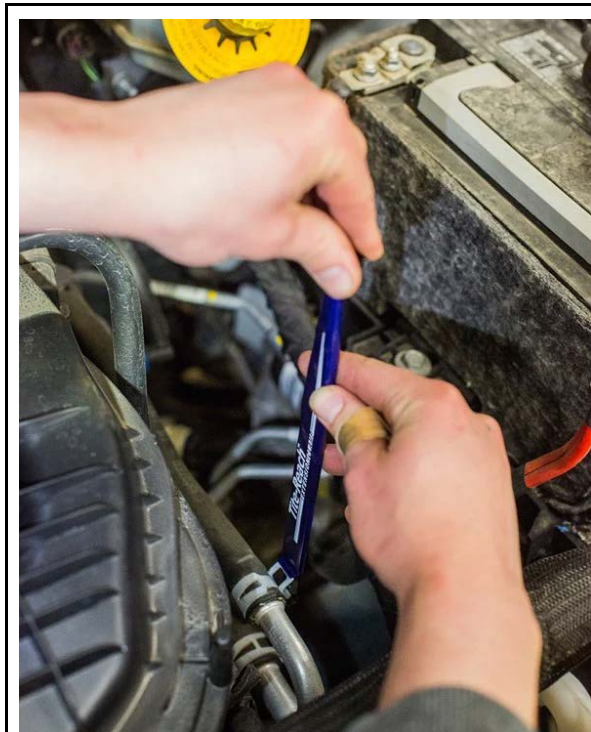

TTR-027

VA 2-328-515

Reg. Date
11/11/2022

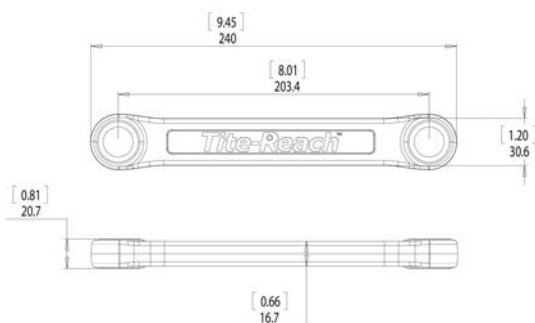

TTR-028

VA 2-329-848

Reg. Date
11/17/2022

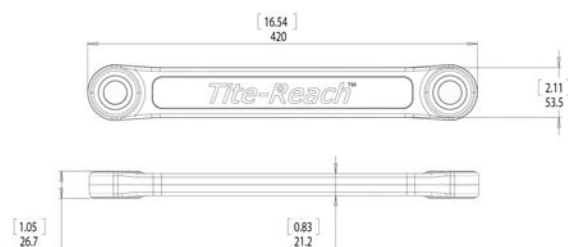

TTR-029

VA 2-328-515

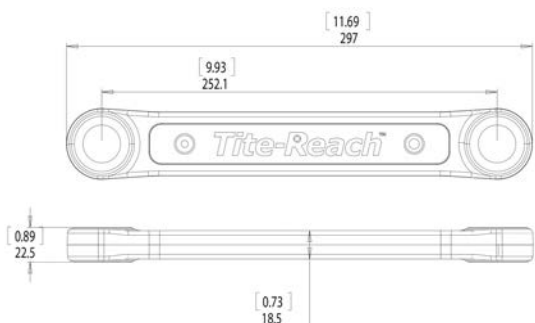

Reg. Date
11/11/2022



TTR-030

VA 2-328-515

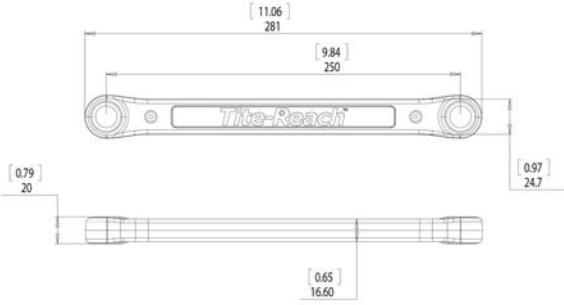
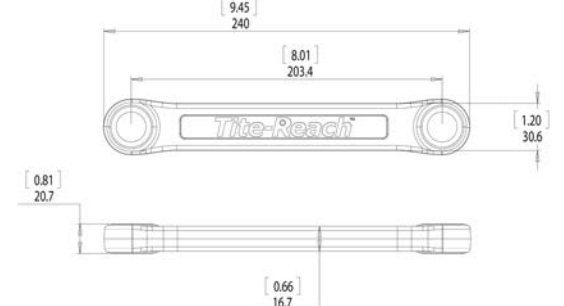
Reg. Date
11/11/2022

	<p>TTR-031</p>	<p>VA 2-328-515</p> <p>Reg. Date 11/11/2022</p>
	<p>TTR-032</p>	<p>VA 2-328-515</p> <p>Reg. Date 11/11/2022</p>
	<p>TTR-033</p>	<p>VA 2-327-778</p> <p>Reg. Date 11/11/2022</p>



US00D607289S

(12) **United States Design Patent**
Lambert

(10) **Patent No.:** **US D607,289 S**
(45) **Date of Patent:** **** Jan. 5, 2010**

- (54) **SLIM PROFILE WRENCH**
- (75) Inventor: **J. Ewing Lambert**, Indianola, IA (US)
- (73) Assignee: **TR Tools, L.L.C.**, Orange City, IA (US)
- (**) Term: **14 Years**
- (21) Appl. No.: **29/339,570**
- (22) Filed: **Jul. 2, 2009**
- (51) **LOC (9) Cl.** **08-05**
- (52) **U.S. Cl.** **D8/28**
- (58) **Field of Classification Search** D8/21-29;
81/60-63.2, 176.119, 120, 121.1, 124.3,
81/177.75, 177.7, 177.85, 186, 176.1, 176.15,
81/176.2; 206/373, 378; 16/429; 7/100,
7/138, 168

See application file for complete search history.

(56) **References Cited**

U.S. PATENT DOCUMENTS

- 562,689 A 6/1896 Willows
- 730,509 A 6/1903 Baker
- 835,034 A * 11/1906 Riddle 81/61
- 1,310,641 A 7/1919 Welch
- 1,350,315 A 8/1920 Katzmarek
- 1,635,102 A 7/1927 Watson
- 1,747,527 A 2/1930 Peterson
- 2,322,856 A 6/1943 LeRoue
- 2,421,038 A * 5/1947 Schultz 81/61
- 2,466,456 A 4/1949 Lybyer
- 2,669,147 A 2/1954 Koenig
- 2,830,479 A 4/1958 Finn
- 3,138,983 A 6/1964 Frizzell
- 3,270,597 A 9/1966 Neff et al.
- 3,283,621 A 11/1966 Faso
- D214,018 S * 5/1969 Traughber D8/25
- D225,606 S * 12/1972 Teichmeier D8/25
- 3,714,852 A 2/1973 Giangrasso
- 3,838,614 A 10/1974 Odonnell
- 3,987,691 A 10/1976 Savage
- 4,063,475 A 12/1977 Perkins
- 4,231,271 A * 11/1980 Yamada 81/57.3
- 4,366,731 A 1/1983 Vallevand

- 4,406,186 A 9/1983 Gummow
- 4,488,461 A 12/1984 Hurtig
- 4,491,042 A 1/1985 Lopochonsky
- 4,534,245 A 8/1985 Rossmann
- 4,593,585 A 6/1986 Hurtig
- 4,748,875 A 6/1988 Lang
- 4,817,475 A 4/1989 Kelly et al.
- 4,819,521 A 4/1989 Lang
- 4,838,131 A 6/1989 Rhoades
- 4,867,016 A 9/1989 DiEdwardo
- 5,144,869 A * 9/1992 Chow 81/63
- D332,730 S * 1/1993 Usuda D8/25
- 5,199,332 A 4/1993 Batten
- 5,355,751 A 10/1994 Specht
- 5,477,758 A 12/1995 Cunningham

(Continued)

FOREIGN PATENT DOCUMENTS

- GB 2 056 348 3/1981

Primary Examiner—Philip S Hyder
Assistant Examiner—Randall H Gholson
 (74) *Attorney, Agent, or Firm*—McKee, Voorhees & Sease, P.L.C.

(57) **CLAIM**

The ornamental design for a slim profile wrench, as shown and described.

DESCRIPTION

- FIG. 1 is a perspective view of the slim profile wrench of the present invention.
- FIG. 2 is a top plan view of the wrench.
- FIG. 3 is a bottom plan view of the wrench.
- FIG. 4 is a side elevation view of the wrench, with the opposite side being identical; and,
- FIG. 5 is an end elevation view of the wrench, with the opposite end view being identical.

1 Claim, 3 Drawing Sheets

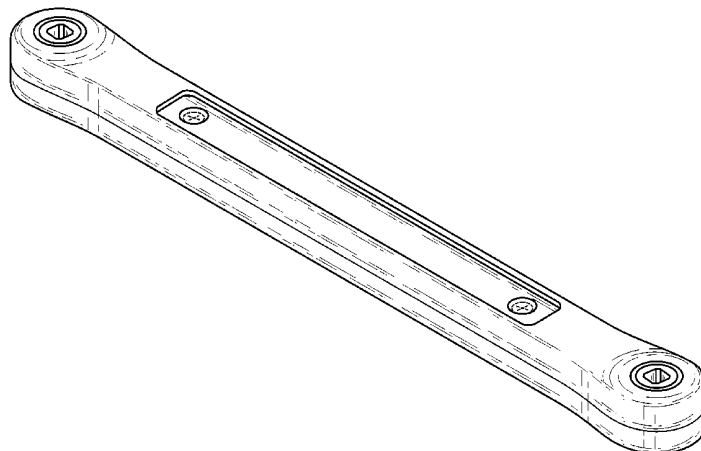

US D607,289 S

Page 2

U.S. PATENT DOCUMENTS

5,540,122	A *	7/1996	Lund	81/57.3	6,752,048	B1	6/2004	Chiang	
5,709,137	A	1/1998	Blacklock		6,832,531	B1 *	12/2004	Marquardt	81/57.3
5,732,605	A	3/1998	Mann		6,877,404	B2	4/2005	Chen	
5,996,448	A	12/1999	Suekage		6,928,904	B2	8/2005	Hsien	
6,032,555	A	3/2000	Whitley		6,993,998	B1	2/2006	Kao et al.	
6,053,076	A	4/2000	Barnes		7,055,409	B2	6/2006	Hsien	
6,151,996	A	11/2000	Whiteford		7,093,519	B1	8/2006	Huang	
6,234,049	B1	5/2001	Ju et al.		7,137,319	B2	11/2006	Hough	
6,257,102	B1	7/2001	Perry		7,197,965	B1	4/2007	Anderson	
6,286,396	B1	9/2001	Johnson		2002/0069728	A1	6/2002	Kady et al.	
6,311,583	B1	11/2001	Izumisawa		2005/0120836	A1	6/2005	Anderson	
6,588,304	B2	7/2003	Kady et al.		2006/0266167	A1	11/2006	Cole	
D486,366	S	2/2004	Tuanmu		2007/0074607	A1	4/2007	Balls	

* cited by examiner

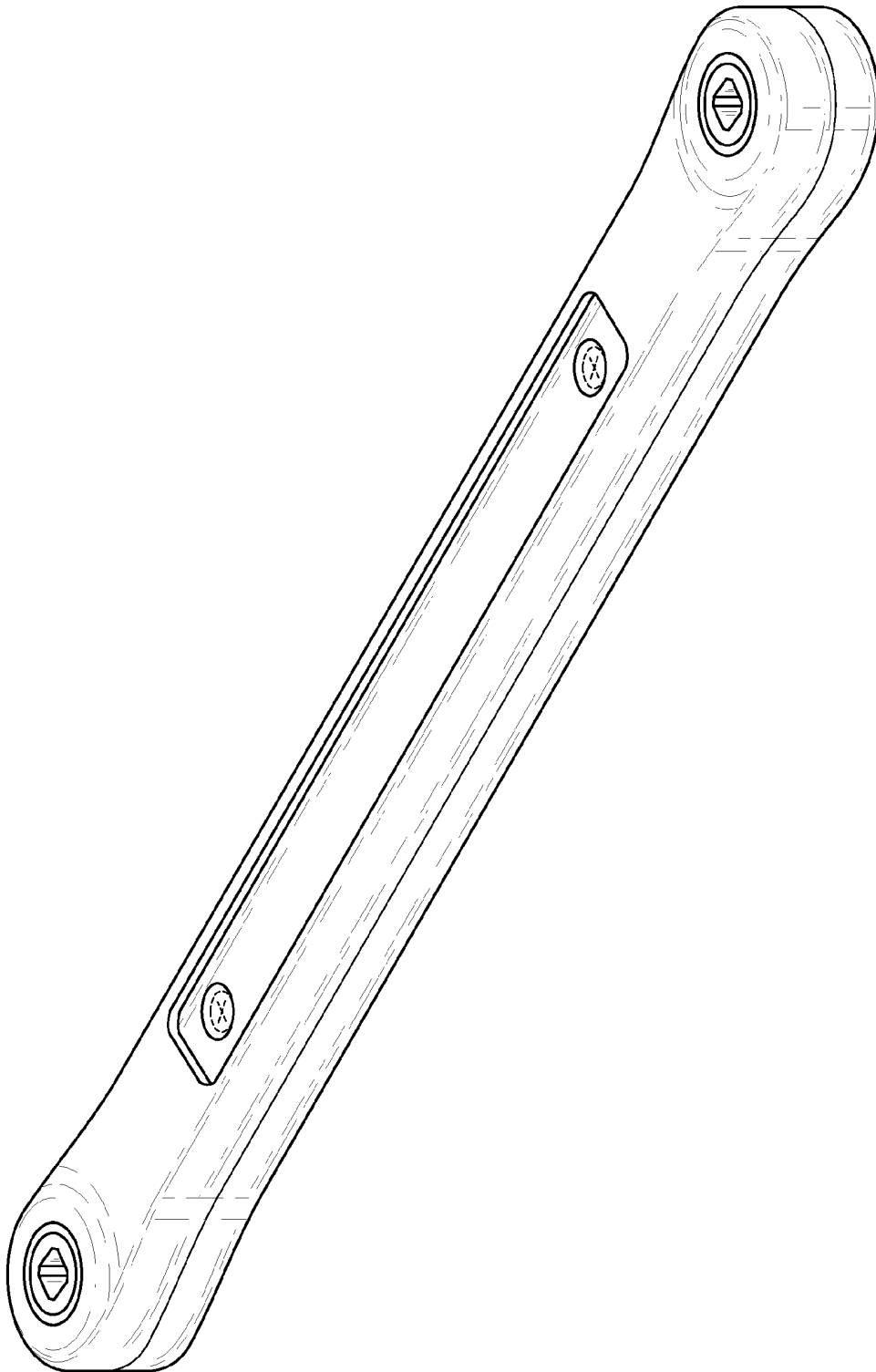

FIG. 1

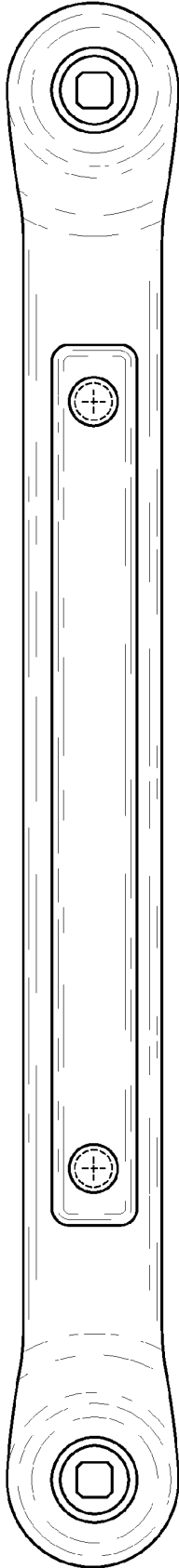

FIG. 2

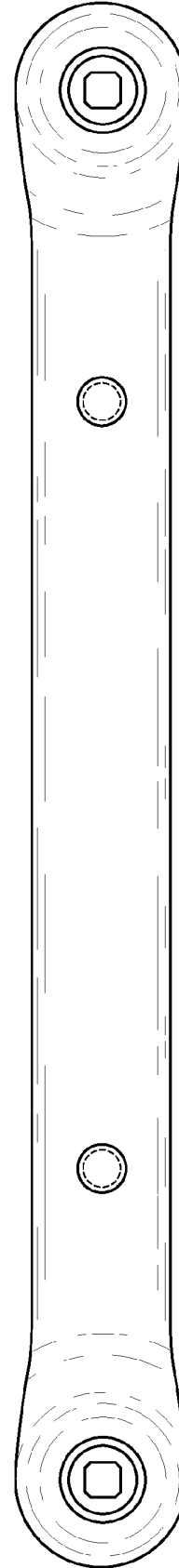

FIG. 3

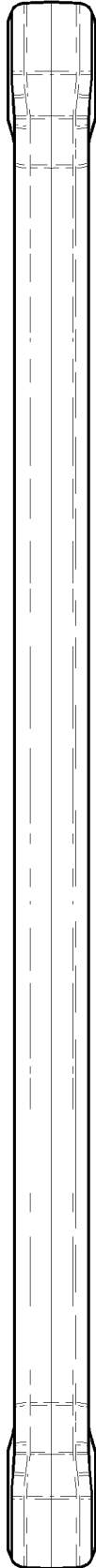

FIG. 4

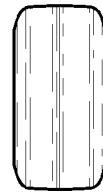

FIG. 5

United States of America

United States Patent and Trademark Office

Tite-Reach

◆ EXTENSION WRENCH ◆

Reg. No. 5,506,965

Registered Jul. 03, 2018

Int. Cl.: 8

Trademark

Principal Register

TR Tools (IOWA LIMITED PARTNERSHIP), AKA Tite-Reach
317 7th St Nw
Orange City, IOWA 51041

CLASS 8: Extensions for hand tools

FIRST USE 10-31-2009; IN COMMERCE 10-31-2009

The mark consists of the stylized wording "TITE-REACH" with a diamond in the letter "R", over a design featuring a wrench that contains the wording "EXTENSION WRENCH." The wrench contains a diamond in the holes on its left and right sides.

No claim is made to the exclusive right to use the following apart from the mark as shown: "TIGHT-REACH" AND "EXTENSION WRENCH"

SER. NO. 87-679,833, FILED 11-10-2017



Andrei Iancu

Director of the United States
Patent and Trademark Office

REQUIREMENTS TO MAINTAIN YOUR FEDERAL TRADEMARK REGISTRATION

WARNING: YOUR REGISTRATION WILL BE CANCELLED IF YOU DO NOT FILE THE DOCUMENTS BELOW DURING THE SPECIFIED TIME PERIODS.

Requirements in the First Ten Years*

What and When to File:

- **First Filing Deadline:** You must file a Declaration of Use (or Excusable Nonuse) between the 5th and 6th years after the registration date. See 15 U.S.C. §§1058, 1141k. If the declaration is accepted, the registration will continue in force for the remainder of the ten-year period, calculated from the registration date, unless cancelled by an order of the Commissioner for Trademarks or a federal court.
- **Second Filing Deadline:** You must file a Declaration of Use (or Excusable Nonuse) and an Application for Renewal between the 9th and 10th years after the registration date.* See 15 U.S.C. §1059.

Requirements in Successive Ten-Year Periods*

What and When to File:

- You must file a Declaration of Use (or Excusable Nonuse) and an Application for Renewal between every 9th and 10th-year period, calculated from the registration date.*

Grace Period Filings*

The above documents will be accepted as timely if filed within six months after the deadlines listed above with the payment of an additional fee.

***ATTENTION MADRID PROTOCOL REGISTRANTS:** The holder of an international registration with an extension of protection to the United States under the Madrid Protocol must timely file the Declarations of Use (or Excusable Nonuse) referenced above directly with the United States Patent and Trademark Office (USPTO). The time periods for filing are based on the U.S. registration date (not the international registration date). The deadlines and grace periods for the Declarations of Use (or Excusable Nonuse) are identical to those for nationally issued registrations. See 15 U.S.C. §§1058, 1141k. However, owners of international registrations do not file renewal applications at the USPTO. Instead, the holder must file a renewal of the underlying international registration at the International Bureau of the World Intellectual Property Organization, under Article 7 of the Madrid Protocol, before the expiration of each ten-year term of protection, calculated from the date of the international registration. See 15 U.S.C. §1141j. For more information and renewal forms for the international registration, see <http://www.wipo.int/madrid/en/>.

NOTE: Fees and requirements for maintaining registrations are subject to change. Please check the USPTO website for further information. With the exception of renewal applications for registered extensions of protection, you can file the registration maintenance documents referenced above online at <http://www.uspto.gov>.

NOTE: A courtesy e-mail reminder of USPTO maintenance filing deadlines will be sent to trademark owners/holders who authorize e-mail communication and maintain a current e-mail address with the USPTO. To ensure that e-mail is authorized and your address is current, please use the Trademark Electronic Application System (TEAS) Correspondence Address and Change of Owner Address Forms available at <http://www.uspto.gov>.